

**PNEUMATIC UNDERWATER
DRILL FOR EXTRACTING
CORAL CORES**

By

**Tomoko Bell
Tetsuya Endo
John W. Jenson
Ryan F. Bell
Mark A. Lander**

WERI

**WATER AND ENVIRONMENTAL RESEARCH INSTITUTE
OF THE WESTERN PACIFIC
UNIVERSITY OF GUAM**

Technical Report No. 135

October 2011

PNEUMATIC UNDERWATER DRILL FOR EXTRACTING CORAL CORES

By

Tomoko Bell¹

Tetsuya Endo²

John W. Jenson¹

Ryan F. Bell

Mark A. Lander¹

¹ Water and Environmental Research Institute of the Western Pacific,
University of Guam UOG Station, Mangilao, Guam 96923

² Celery Corporation
1-7-9 Tsumada-Nishi Atsugishi Kanagawa, Japan

**Technical Report No. 135
October 2011**

The activities on which this report is based were financed in part by the Department of the Interior, U.S. Geological Survey, Guam Hydrologic Survey and Pacific ENSO Application Center, through the University of Guam Water and Environmental Research Institute of the Western Pacific. The content of this report does not necessarily reflect the views and policies of the Department of the Interior, nor does the mention of trade names or commercial products constitute their endorsement by the United States Government.

ABSTRACT

Global climate history has been receiving great attention worldwide, and geochemical climate studies using corals cores extracted by underwater drilling have been widely conducted. We report here that it is feasible to extract a coral core, 80 mm in diameter and at least 0.9 m in length, by using a customized pneumatic drill and a gasoline-powered air compressor. With our innovative drill, we achieved four objectives which will significantly contribute to the convenience and reliability of coral core sampling in the field: (1) less cost (2) more portability (3) easier and faster drilling operations (4) collection of an intact coral core. The key to replacing the common and current underwater drilling method was installing an air motor instead of using a regular hand-held pneumatic drill. In addition, we attached a pneumatic water pump which provided a continuous water flow to clean the diamond drill bit. We expect this drill to be used extensively by climate researchers and others interested in retrieving high-quality coral core samples with the most cost-efficient method and least labor-intensive technique. This technology could, in fact, revolutionize underwater drilling methodology by providing researchers an economical and ecologically-safer option over the more cumbersome and expensive hydraulic drill.

KEYWORDS: Coral Core, Underwater Drill, Pneumatic Drill

Nadeshiko

Customized underwater drill developed by Water and Environmental Research Institute of the Western Pacific, University of Guam and Celery Corporation, Japan.

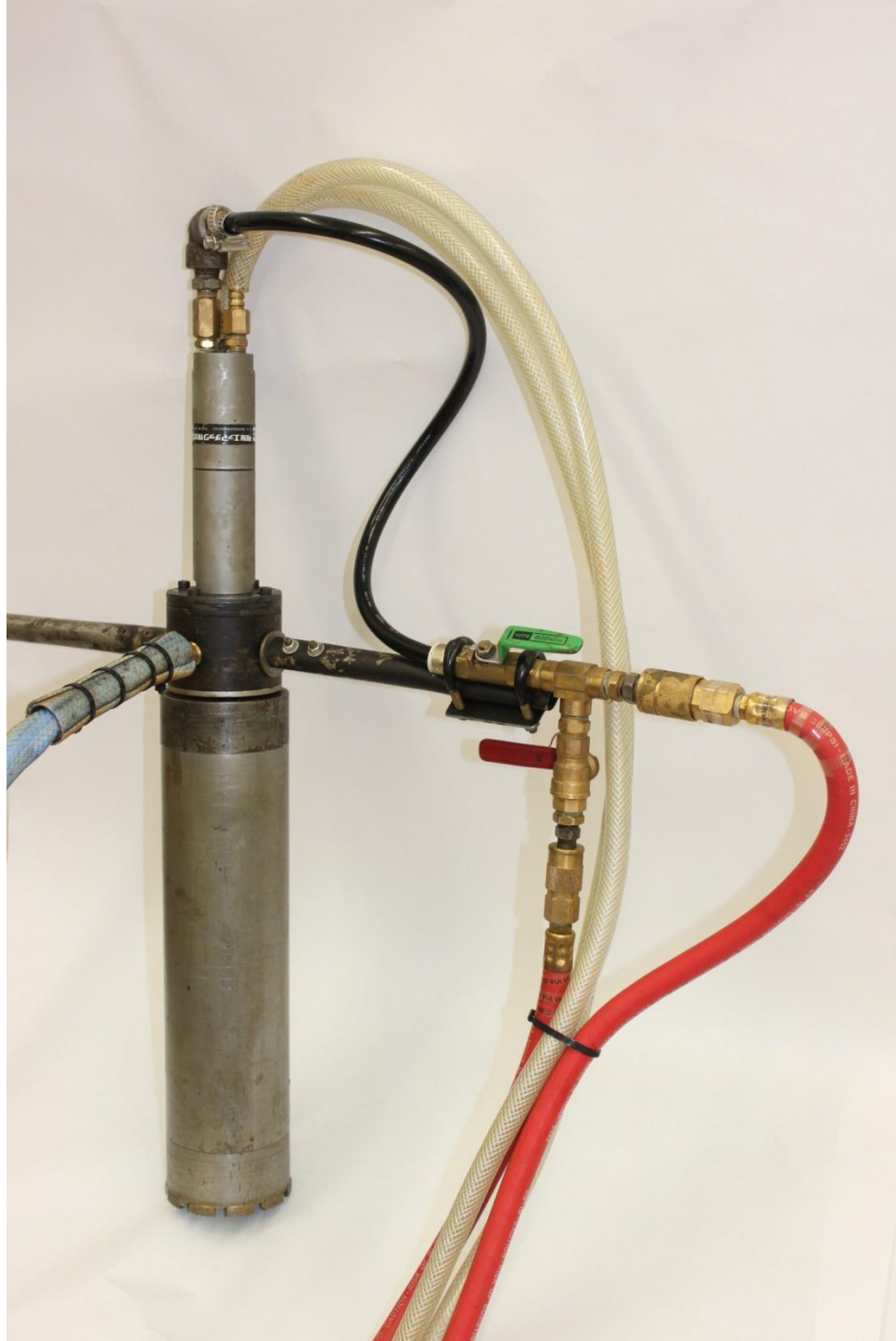

ACKNOWLEDGEMENTS

I would like to thank to Dr. Judson Partin and Dr. Fred Taylor from the University of Texas-Austin for valuable advice on underwater drilling. Thank you very much to Mr. Jason Miller, dive safety officer, UOG Marine Laboratory, for tremendous assistance in the field. Thank you to Guam Department of Agriculture for issuing the permit for coral sampling, and the US Navy for the boat access to Gabgab Beach.

Tomoko Bell

TABLE OF CONTENTS

Acknowledgements.....	i
Table of Contents.....	ii
List of Figures.....	iii
1.0 Introduction.....	1
2.0 Drill Structure.....	2
2.1 Air motor.....	2
2.2 Tube.....	4
2.3 Drill bit.....	4
2.4 Hoses.....	4
3.0 Drill Accessories.....	6
3.1 Wrench.....	6
3.2 Core breaker.....	6
3.3 Water pump.....	6
4.0 Drill Assembly Operation.....	8
4.1 Preparation.....	8
4.2 Operating Procedures.....	8
5.0 Maintenance.....	9
6.0 Discussion.....	9
References.....	10
Appendix A Preparation/operation checklist for a user.....	11
Appendix B Underwater drill blue prints.....	13
Appendix C Field notes from past drilling.....	16
Appendix D Inventory Checklist.....	17

List of Figures

Figure 1. Air motor full body without hoses and handles.....	2
Figure 2. Air motor top close up.....	3
Figure 3. Valves on left handle	4
Figure 4. Tube Segment.....	5
Figure 5. Diamond drill bit	6
Figure 6. Wrenches to disassemble tubes and bit	7
Figure 7. Water pump assembly	8

1.0 Introduction

For geochemical climate research on Guam using a coral core, we found it necessary to develop a new methodology for underwater drilling; a low-cost, easily portable underwater drill for obtaining coral core samples in shallow water (<10 m). This proved to be very successful, and the drill itself thus constitutes a significant advance in the technology and methodology for this type of research. Coral core sampling methods have been developed since the 1980's (Easton, 1981, Isdale and Daniel, 1989; Kan et al., 1998) and there are three common methods for underwater drilling: (1) hydraulic (2) pneumatic and (3) electric. Since coral does not grow exactly vertical to the sea floor, coral cores for paleoclimate studies should be about 80 mm in diameter in order to contain the full, consecutive record along the coral growth axis. Given this width of core, the hydraulic drill is the most popular method to extract the core because of its power and high torque specifications. However, Adachi and Abe (2003) noted that hydraulic drills are expensive and inconvenient to transport; they usually cost about \$12,000 and weigh 1000 kg or more. Moreover, hydraulic drills require longer setup time and skilled operators. To overcome all these disadvantages of hydraulic drills, Adachi and Abe (2003) invented a pneumatic drill which can drill coral cores up to 10 m long and 55 mm in diameter. Their drill costs about \$2,000 and can be packed in two suitcases for remote sampling. The air source for their drill is common scuba tanks. This technology, however, requires frequent scuba tank changes underwater and extra trips to the surface to send up segmented coral cores. With current methods, it is common to deliberately break the core to extract it, requiring divers to make repeated trips to the surface, thus requiring longer diving time and more time on site.

Inspired by Adachi's pneumatic drill, and mindful of these sorts of limitations with the current technology, we decided to pursue a pneumatic drill able to extract a core 80 mm in diameter without requiring the breaking of coral cores or using scuba tanks. The most innovative characteristics of this drill are: (1) using an air motor instead of a regular pneumatic drill to deliver higher torque (2) using an air compressor aboard the boat instead of scuba tanks to send continuous air to the drill, and (3) using modular coring tubes to retrieve cores. In the currently available methods, all the pneumatic drills have only one handle, making it difficult for the driller to drill vertically. Using an air motor with two handles gives not only higher torque but also greater stability underwater. Replacing scuba tanks with an air compressor eliminates the changing of tanks underwater, and lets the driller adjust the volume of air flow. Modular core tubes are easily attached or detached, depending on the length of the core, by using two custom wrenches. Furthermore, our tool kit included a core guide to stabilize the drill bit when initializing drilling.

There are two critical factors for drilling efficiently: (1) washing the core bit continuously and (2) getting rid of drilling debris. In our method, we used a pneumatic drill with a water pump to send fresh sea water to the core bit and purge debris. The water pump is connected to the same air source as the motor, so it does not require an additional power source. With cautious engineering, our pneumatic drill has worked outstandingly both on land and underwater, and required less than 30 minutes to drill an approximately one-meter length coral core. We are confident that this drill can significantly contribute to paleoclimatology and other research that uses coral cores.

2.0 Drill Structure

Our drill is divided into three main components: (1) air motor (2) tube (3) diamond drill bit. Each part can be connected by hand and disassembled by the customized wrenches described in section 3.0.

2.1. Air Motor

The air motor is the most important part of this drill. We chose a Japanese company, Meiyu, to supply the air motor (model DF-67-093) for our drill. The specifications for this air motor are 0.6 megapascals and 350 revolutions per minute. There are two valves for this motor on the handle as shown in Figure 3: (1) the green valve controls the air flow to the air motor, and (2) the red valve controls the water pump described in section 3.3.

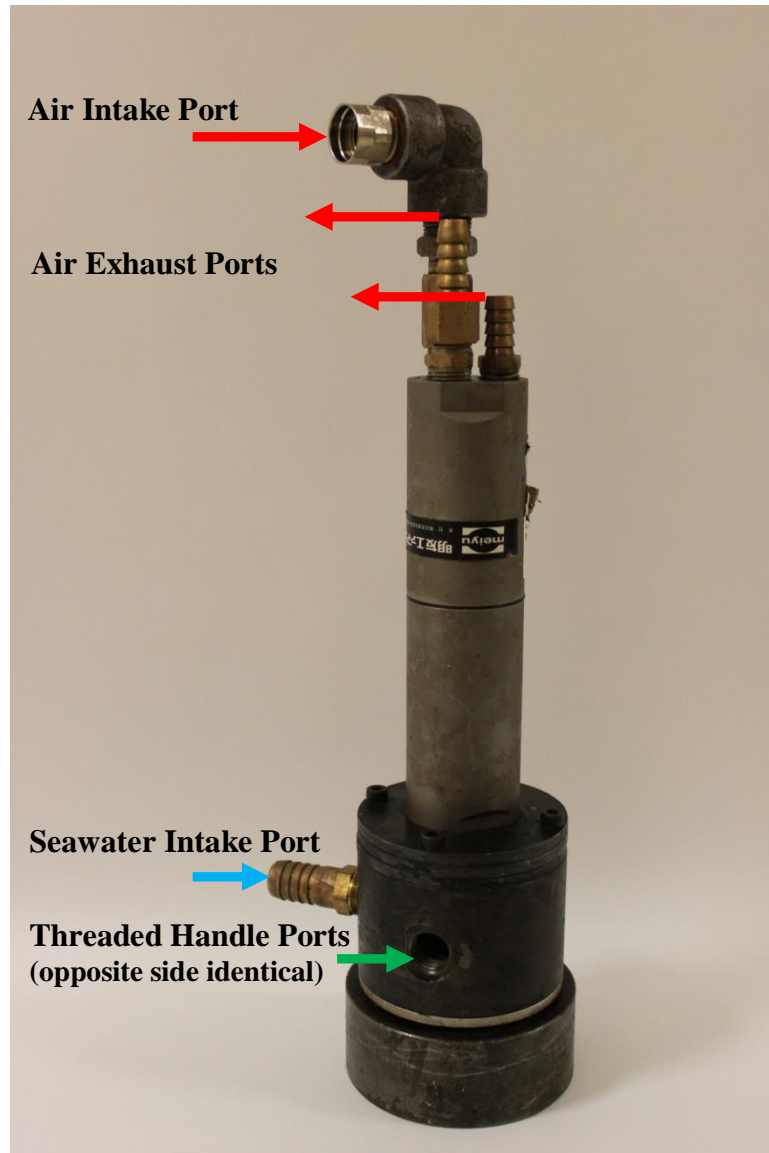

Figure 1. Air motor full body without hoses and handles.

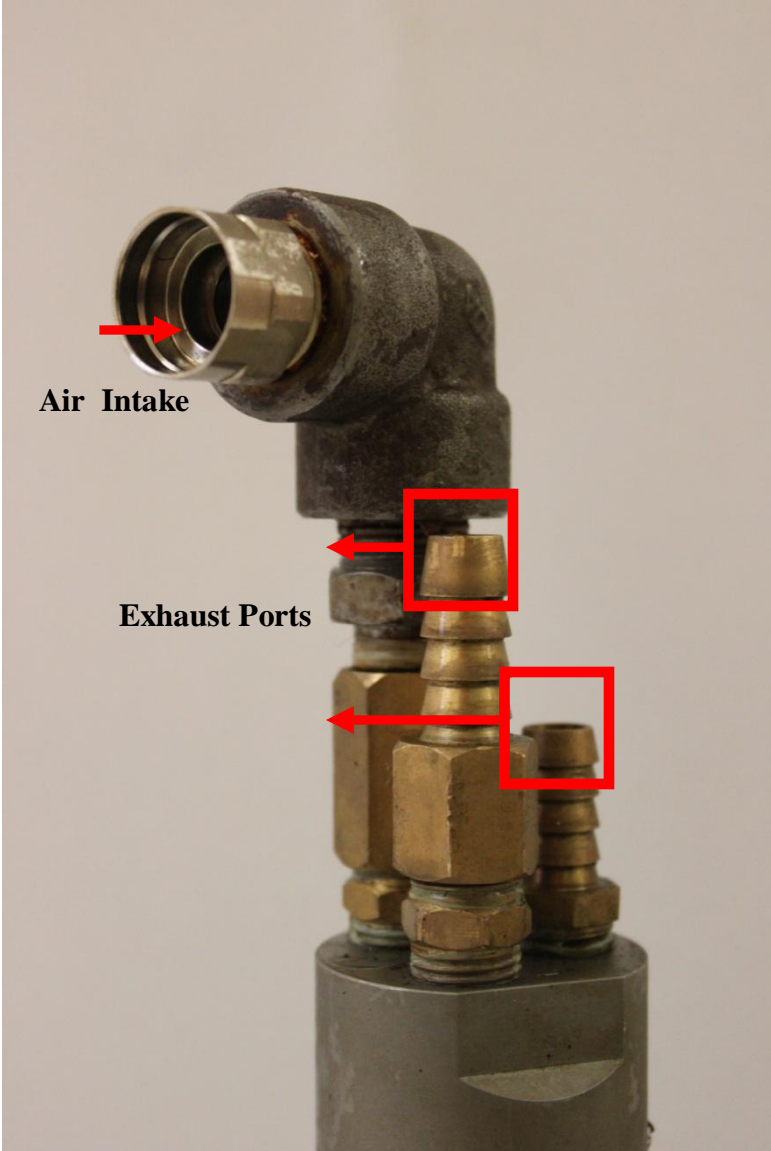

Figure 2. Air motor top, close up.

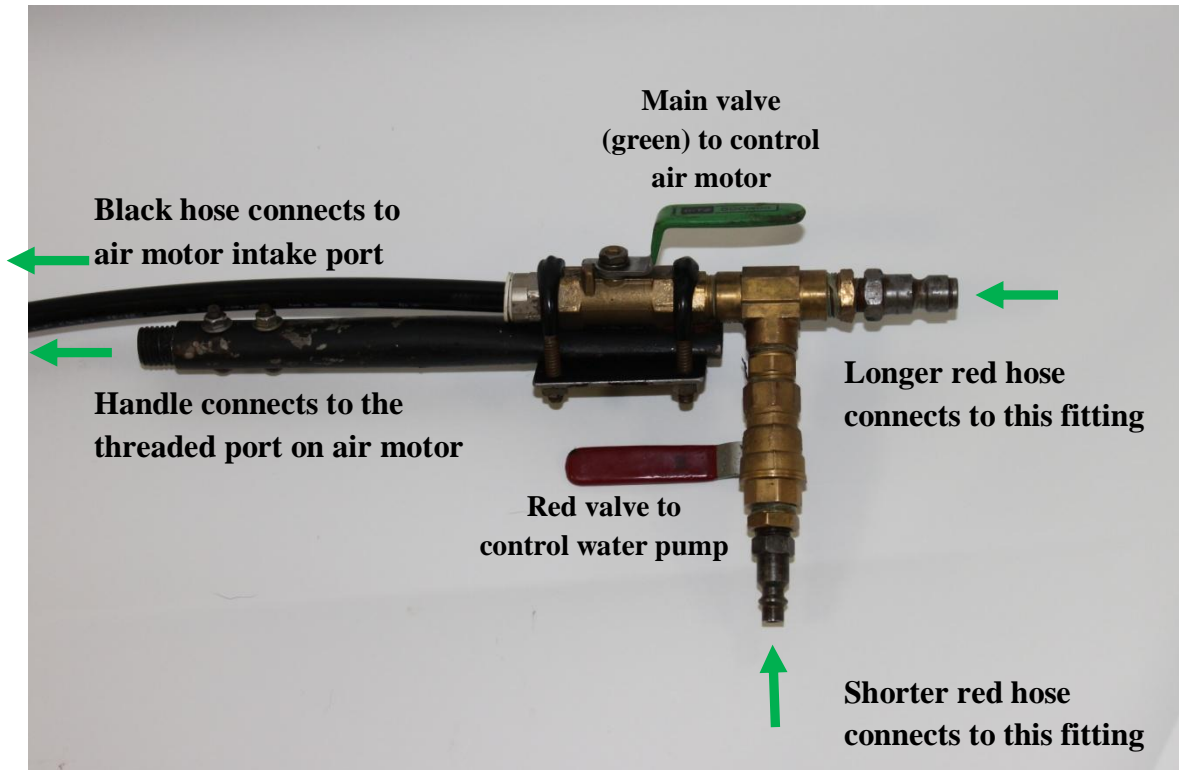

Figure 3. Valves on left handle.

2.2. Tube

Each tube is 310 mm long (Figure 4), and the number of tubes used can be adjusted depending on the desired length of the core samples. It is recommended to initiate the drilling with using one or two tubes at most to keep the drill stable.

2.3. Diamond drill bit

Although the diamond drill bit (Figure 5) is the most expensive part of the drill, this part needs to be replaced when the cutting edge becomes worn after many drilling operations. Thus, it is important to be aware of how many times the bit has been used.

2.4. Hoses

There are five hoses used for the drill: (1) a longer red hose to connect the gasoline-powered air compressor and the main valve on the left handle, (2) a shorter red hose to connect the air gun (water pump assembly) to the red valve on the left handle, (3) a short black hose to send air from the main valve to the air motor, (4) a blue hose to send saltwater from water pump to the air motor, and (5) two transparent hoses to drain the exhaust from the air motor.



Figure 4. Tube segment (31 cm).

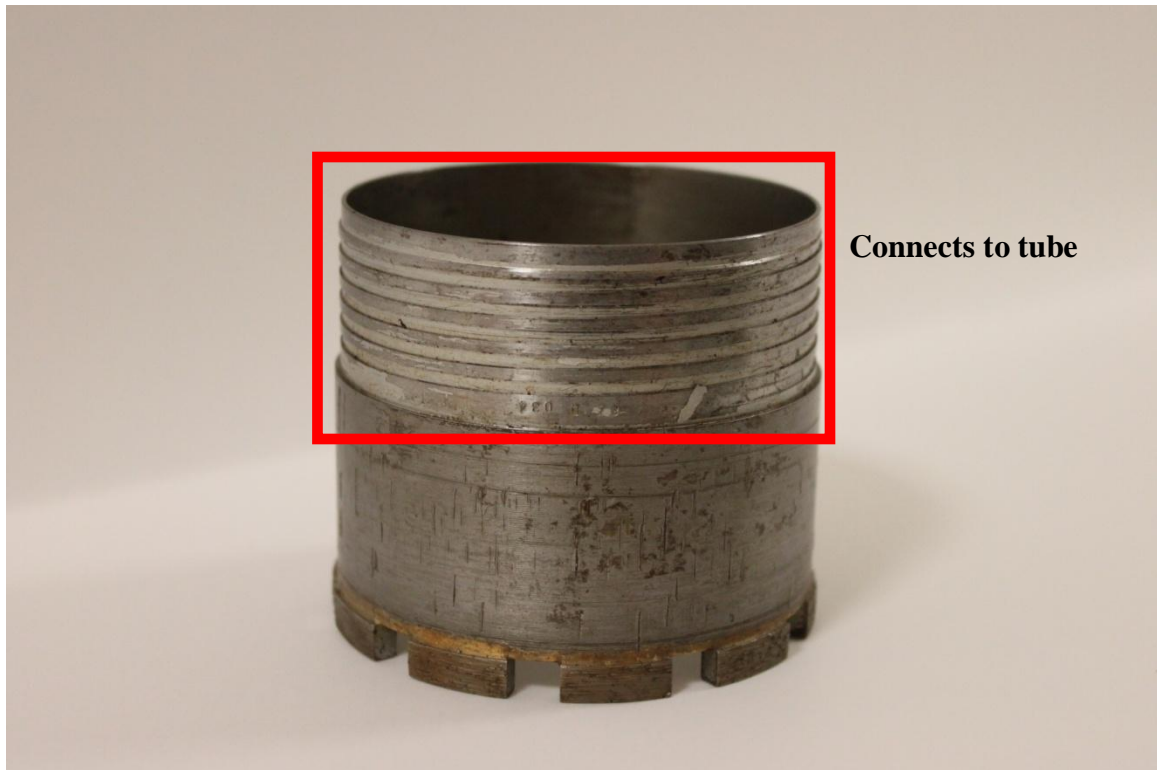

Figure 5. Diamond drill bit.

3.0. Drill accessories

There are four accessories: (1) a wrench, (2) a core breaker, (3) a water pump, and (4) a core guide. Among these four, the core breaker may not be necessary depending on density or fragility of samples. Usually, drilled core will come along with the drill bit and tubes when the drill is pulled out from the coral.

3.1. Wrench

The customized wrenches are required when disassembling the drill assembly at three places: (1) the air motor and tube, (2) tube-to-tube, and (3) tube and diamond drill bit. These wrenches should be held as show in Figure 6.

3.2. Core breaker

The core breaker can be used to separate a drilled coral core from the coral body. It can be inserted and pressed downward to detach the coral core for extraction. However, this may cause unwanted breaks of the core. **This only needs to be used when a coral core doesn't come along when the drill is pulled out from the coral body.** Adachi and Abe (2003) introduced a core breaker which is a narrow stick to break the core after drilling. Unlike their core breaker, ours is a half-circle to prevent the core from being broken internally.

3.3. Water pump

The water pump is very important to make the drilling process efficient by removing drilled coral debris from the drill bit. Sea water flows from the water pump to

the air motor through the blue hose, and flows through the interior of the tube to the drill bit. There is a metal filter installed on the water pump intake to prevent the pump from ingesting small fragments or marine life. This pump is connected to the small air gun (Figure 7) and is initiated by the red valve on the left handle described in section 2.1 (Figure 3).



Figure 6. Wrenches to disassemble tubes and bit.

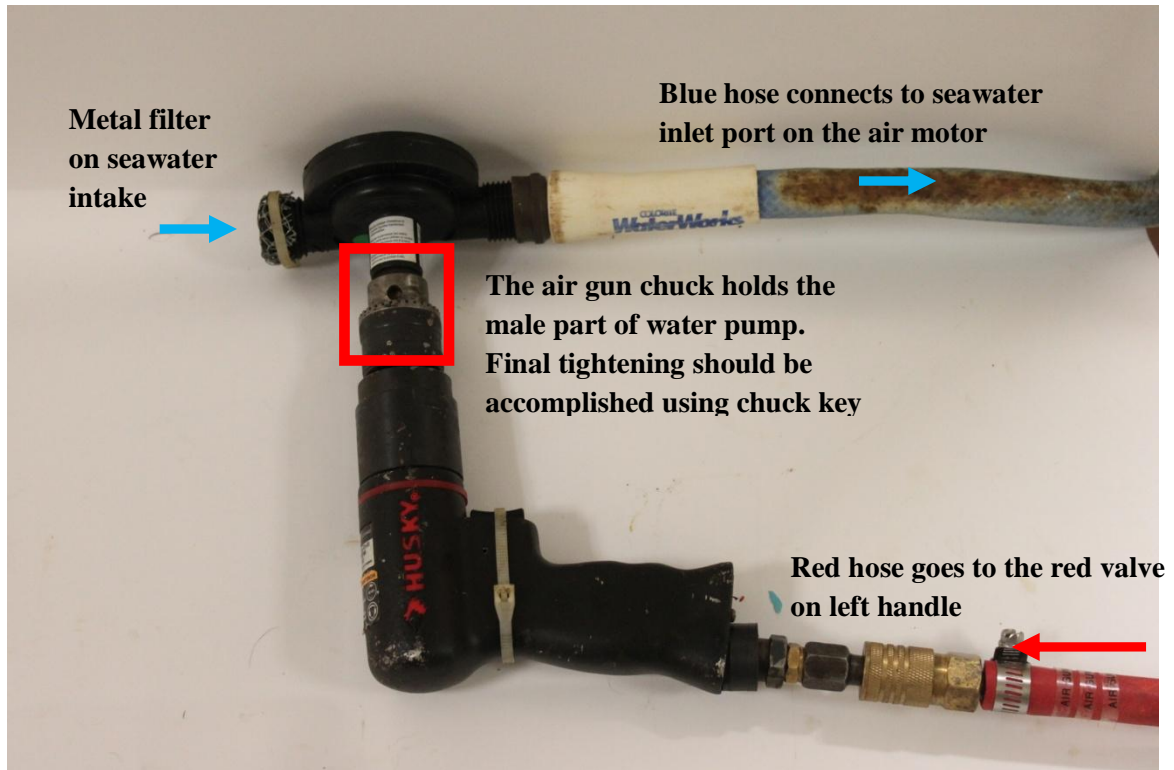

Figure 7. Water pump assembly.

4.0. Drill Assembly Operation

4.1. Preparation

First, all the threads on the air motor, tubes, and drill bit should be well greased with silicone grease when assembling. After properly lubricating the parts, assemble the first tube to the air motor by screwing them together until hand-tight. It is easier to start the drilling with a shorter assembly, so we recommend connecting at most two tubes to the air motor when initiating the drill. After connecting tube(s) to the air motor, connect the drill bit to the tube assembly until hand tight. Next, the two handles, one without valves (right handle) and the other one without valves (left handle) should be screwed to the side of the air motor body (Figure 1). Note: ensure the flat washer is placed between the handle and air motor body to prevent damage to the assembly. It may be necessary to use a pipe wrench to ensure the handles are securely attached to the air motor; do not over-tighten.

Next, the hoses need to be attached to the assembled drill. The short black hose attached to the main valve is inserted into the intake port on top of the air motor (Figure 2). The quick-disconnect fitting (QD) on the end of the longer red hose goes to the main valve, the QD on the end of the shorter red hose goes to red valve, the two transparent hoses connect to the exhaust ports on the top of air motor (Figure 2), and the cut end of the blue hose connects to the seawater intake port on the center of the air motor (Figure 1).

Third, the water pump is connected to the threaded end of blue hose, and the air gun is connected to the water pump. The air gun chuck can change size by turning the

chuck to hold the male part of the water pump. The chuck key should be used to finish tightening the chuck to the water pump. Connect the other end of the shorter red hose to the bottom of air gun (Figure 7).

Lastly, ensure all the valves are in the off-position, and then connect the other end of the longer red hose to the gasoline-powered air compressor.

4.2. Operating Procedures

It is recommended to do a test drill on land before deploying for field work. This will allow for an operational check to be performed on the three critical components: (1) the gasoline-powered air compressor, (2) the air motor, (3) the diamond drill bit. A piece of cement or dead coral may be used for the drill test. It is critical during this test for water to be connected to the water-intake port on the air motor to prevent damage to the drill bit. After this test, the air motor, drill bit, and tubes should be immediately disassembled as water can quickly cause corrosion and may ruin the drill assembly.

In the field, the assembled drill will be deployed underwater at coral sample sites. If extra tubes will be needed, wrenches and extra tubes should be deployed right next to the sample underwater. The core guide and core breaker should also be deployed next to the coral sample to aid in drilling and extraction, as needed. After the drill is set up, and the operator on the boat turns on the air compressor, the operator underwater opens the green and red valves, which initiates drilling.

Some tips for underwater drilling: (1) once ready to start drilling, take off your dive fins. By taking off your fins you will be able to move around freely without the cumbersome fins getting in the way of the drilling operation. (2) Use a container or dive bag to prevent losing accessories underwater. Also, the dive bag also makes for a safe way to deploy accessories by raising and lowering to and from the boat using a rope. (3) Anchoring a few ropes around the base of the coral and using two bungee cords can aid in drilling the coral. On our dives, we anchored a rope at the base of the coral, looped it over the top and anchored the opposite end on the other side of the coral. Then, after initiating the drill, we attached a few bungee cords to the rope and wrapped them around the handles to provide a steady downward pressure on the drill. This allowed for easy one-handed operation for most of the drilling operation. Also, the ropes provided a convenient way for the operator stay stable.

5.0. Maintenance

Proper maintenance is extremely important to keep this drill functional. Immediately after sampling underwater, fresh water should be poured all over the drill assembly. The drill bit, tubes, and air motor should be disassembled immediately upon surfacing with wrenches on the boat. Delaying this process will prevent you from being able to disassemble the drill as corrosion caused by saltwater starts within a few minutes of underwater sampling. After coming back to the lab, the two handles and all the hoses should be detached, then soaked and rinsed in fresh water. Meanwhile, the drill bit, tubes, air motor, wrenches, core breaker should be thoroughly rinsed by running under fresh water, and wiped dry. After drying, WD-40 should be sprayed all over the drill and accessories including inside all of the ports of the motor. One 500ml can of WD-40 may be required for this process.

6.0 Discussion

There were three critical concerns about our new drilling system expressed by professionals experienced in both hydraulic and pneumatic methods: (1) in general, pneumatic drills require 800 to 1200 revolutions per minute, while ours was only 350 RPM (2) the bit and tube wall thickness is usually 2 mm while ours was 2.7 mm, which requires additional power to rotate, and (3) our system has no extra air supply system to clean the debris, which tends to accumulate at the bottom of coral samples while drilling. In addition to these concerns, one company specialized in underwater drilling suggested giving up on 80 mm cores and extracting 40 mm cores side by side, as they believed that pneumatic system was not appropriate for 80 mm cores. All the concerns were carefully considered by Celery Corporation. The key to solving all the challenges was to use a powerful air motor instead of the commonly used pneumatic drill, and to use a constant air source provided by a gasoline-powered air compressor instead of scuba tanks.

The reason we had to spend double the expected amount of time to extract the core at Haputo Bay was originally thought to be due to the strong current and the depth which causes a loss of air pressure in the hose connecting to the air motor. However, it turned out that the drilled specimen from Haputo Bay was harder than the one extracted Gabgab Beach. Except for this unexpected condition, we believe that we could have drilled the specimen in much less than an hour. All in all, our method for underwater drilling proved to be a very simple, reliable, portable, and low-maintenance system. The designer, Celery Corporation, is certain that we will be able to extract coral specimens up to 3 m simply by adding extensions.

REFERENCES

- Adachi, H., & Abe, O. (2003). "Air drill" for submerged massive coral drilling. *Marine Technology Society Journal*, 37(2), 31-36.
- Easton, W. H. (1981). A submersible, rechargeable, electric drill. *Atoll Research Bulletin*, 255: 83-90.
- Isdale, P., & Daniel, E. (1989). The design and deployment of a lightweight submarine fixed drilling system for the acquisition of coral cores. *Marine Technology Society Journals*, 23, 3-8.
- Kan, H., Adachi, H., Nakajima, H., & Naito, G. (1998). Development of submersible, diver operating coring device. *Chishitsu News*, 527, 43-47.

Appendix A. Preparation/operation checklist for a user

A. Drill Assembly Parts List		✓ when complete
Drill	1. One air motor	
	2. Two handles with washers	
	3. Three extension tubes	
	4. One diamond drill bit	
Hoses	5. One longer red air hose	
	6. One shorter red air hose	
	7. One short black air hose attached to the left handle	
	8. One blue water hose	
	9. Two transparent exhaust hoses	
Accessories	10. One water pump	
	11. One air gun with chuck key	
	12. Two wrenches	
	13. Core guide	
	14. Core breaker	
B. Drill Assembly Setup (clean all parts with mild soapy water and rinse prior to assembling)		✓ when complete
Drill	15. Lube the threads of air motor, extension tubes and drill bit with silicone	
	16. Connect air motor, tubes and drill bit by hand	
	17. Screw handles with washer in the side holes of air motor	
Hoses	18. Connect longer red hose to the main green valve on the left handle	
	19. Connect shorter red hose to the red valve on the left handle	
	20. Connect the other end of shorter red hose to the air gun	
	21. Connect black skinny hose to the top of the air motor	
	22. Connect the end of blue hose to the brass port in the center of air motor	
	23. Connect the other end of blue hose to water pump	
	24. Connect the two transparent hoses to the two brass air motor exhaust ports	
Water Pump	25. Connect the water pump to air gun. Tighten with chuck key	
Air Compressor	26. Connect the longer red hose to the air compressor (verify air motor valves are OFF)	
C. Drilling (Good luck! Be safe!)		✓ when complete
Deployment	27. Submerge assembled drill and accessories	
	28. Anchor ropes around the coral sample for stability	
	29. Deploy the core guide and assembled drill on the top of the coral	
	30. Take off fins and balance yourself. Hold the rope if necessary	
Initiate Compressor	31. Operator on the boat: start the compressor (turn on fuel and power switch)	
Initiate the Drill	32. Operator underwater: open two valves (green & red) to commence drilling operation	
	33. Pull the drill and install extension tubes, as needed, to reach desired core length	
Stop the Drill	34. Close the two valves (green & red) anytime drilling is stopped	
	35. Retrieve the coral core sample by pulling out the drill. If necessary, use core breaker	
	36. Turn off the compressor (turn off fuel and engine switch)	
	37. Send the sample, drill and accessories to the boat	
D. Cleaning and Maintenance (Please be meticulous!)		✓ when complete
On the Boat	38. Rinse drill assembly and metal accessories with fresh water	
	39. Disassemble air motor, tubes and drill bit with wrenches	
At UOG	40. Unscrew handles and disconnect all the hoses. Soak in freshwater	
	41. Wash air motor, tubes and drill bit thoroughly with running water	
	42. Wash wrenches, core guide and core breaker with running water	
	43. Dry all cleaned components and accessories	
	44. Spray WD-40 to all the parts and accessories. Make sure to spray inside of air motor, tubes & drill bit	
Long Term Storage	45. Periodically inspect all components for corrosion and serviceability	
	46. Clean and reapply WD-40 as necessary.	

APPENDIX B. Underwater drill blueprints

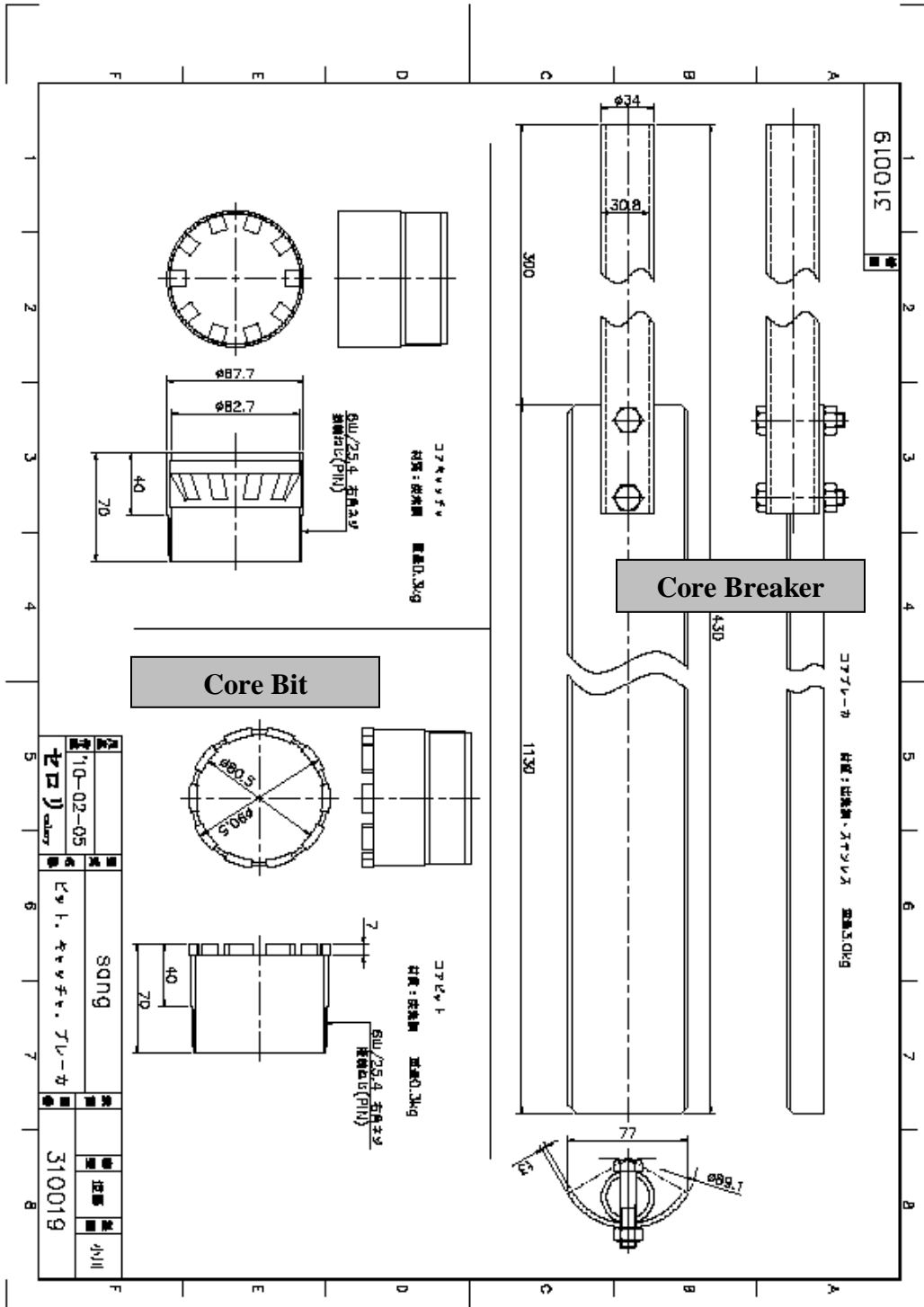

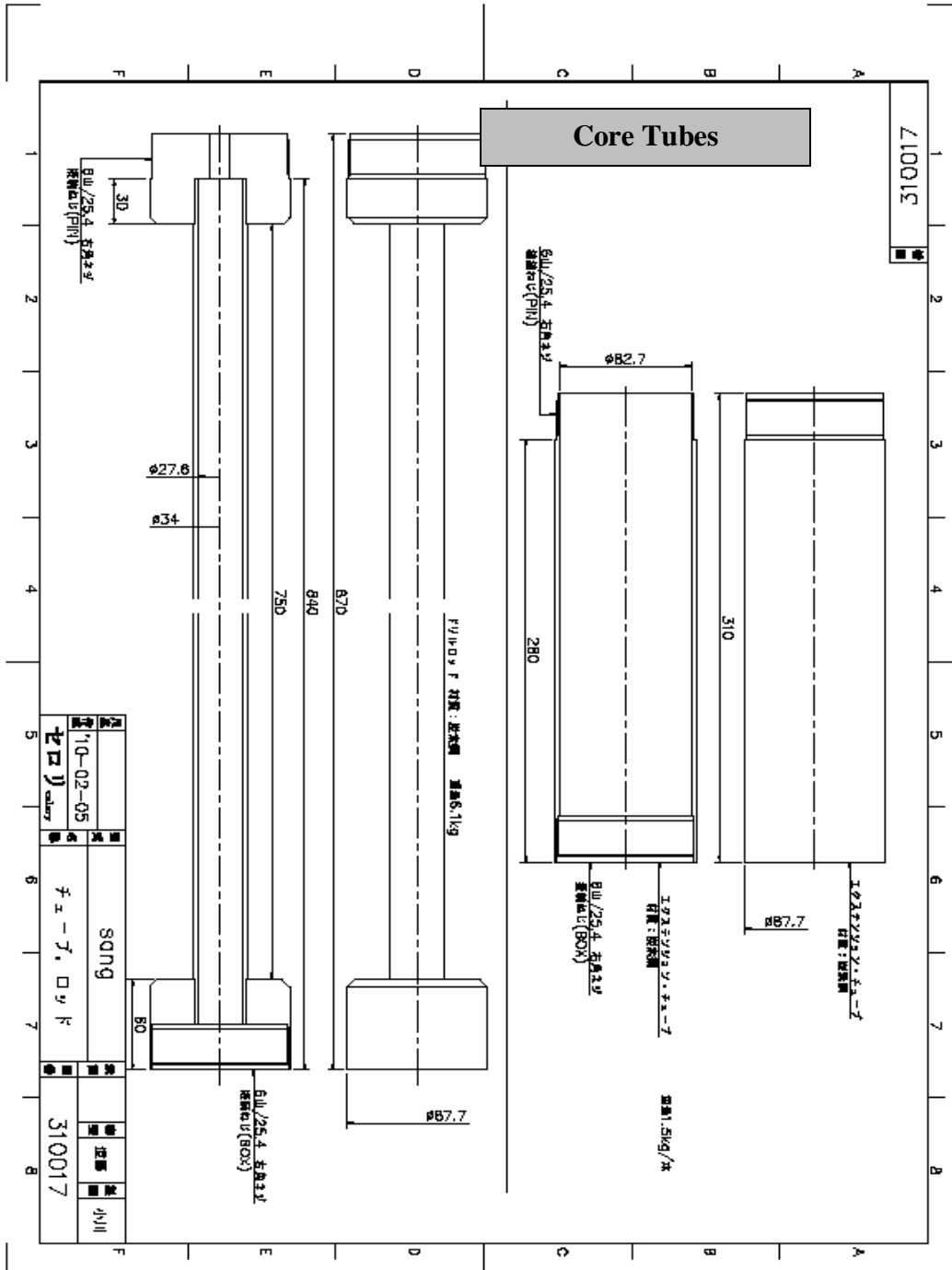

品番	10-02-05	名称	SONG	製造	小川
メーカー	フェー、ロフト	重量	310017	仕様	
規格		材質		備考	
単位	本	数量		その他	

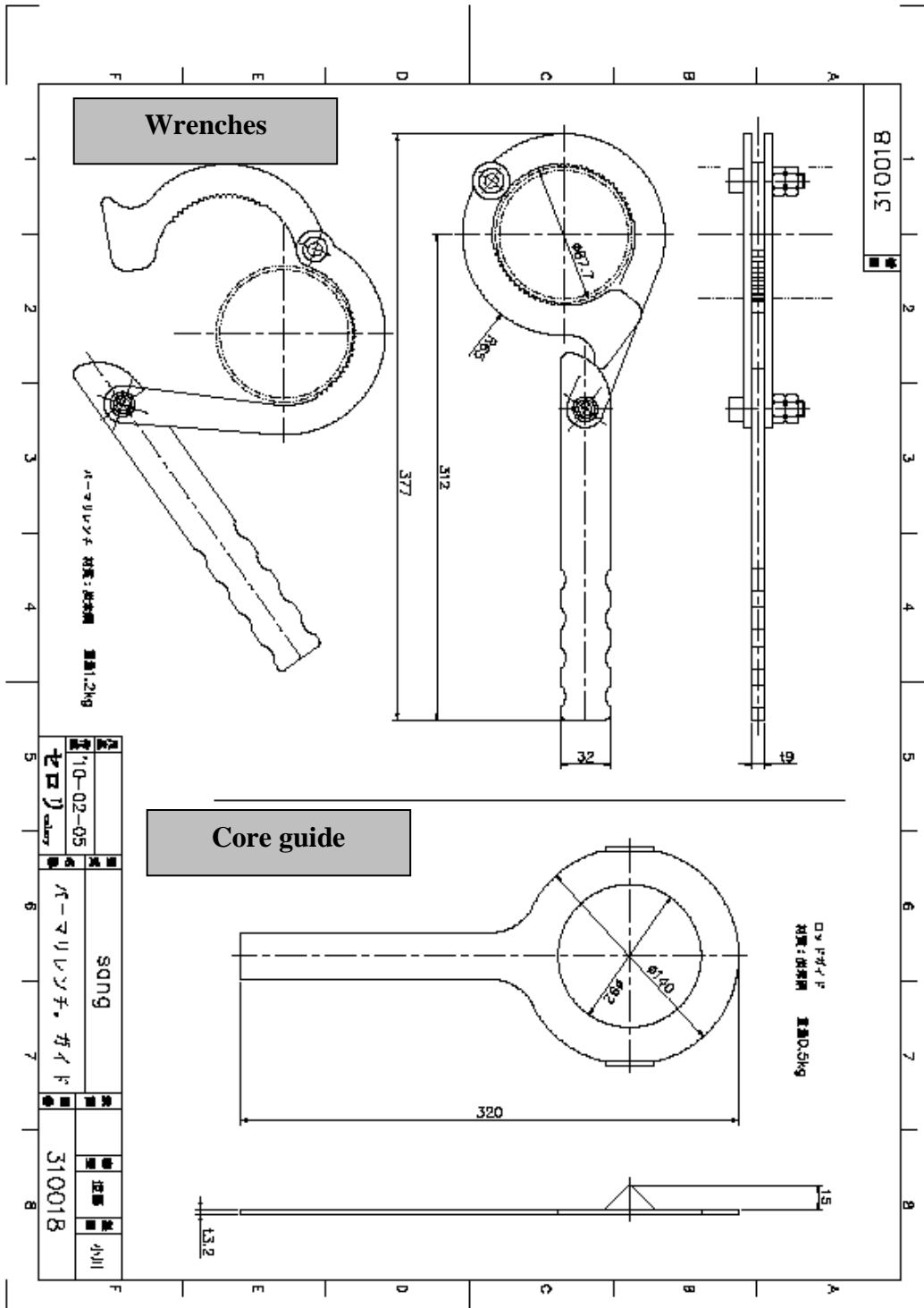

Appendix C. Field notes from past drilling.

Event	Gabgab Beach (07/26/2010)	Haputo Bay (08/11/2010)
Left Marine Lab	9:15	9:30
Arrived at the dock & launched the boat	9:45	9:45
Arrived at the sample site	10:00	10:30
Deployed the drill & tools underwater	10:30	11:00
Set up the rope around the sample	10:30	11:00
Started drilling	10:30	11:00
Finished drilling	11:00	12:30
Left the sample site	11:30	13:00
Arrived at the dock	11:45	13:45
Arrived at the Marine Lab	12:15	14:15
Washed the drill, tools and hoses	13:00	15:00
Dried and wiped all the tools	13:30	15:30
Sprayed WD-40	13:30	15:30

Field Personnel:

07/26/2010: Jason Miller, Tomoko Bell, Ryan Bell

08/11/2010: Jason Miller, Tomoko Bell, Ryan Bell, John Jenson, Blaz Miklavic

Underwater Drill Technical Support:

Tetsuya Endo

Celery Corporation

1-7-9 Tsumada-Nishi Atsugishi Kanagawa, Japan

Phone: 046-222-0247

E-mail: t-endo@celery.co.jp

APPENDIX D. Inventory Checklist

		Quantity	Check
Drill	Air motor	1	
	Handle	2	
	Washer	2	
	Extension Tube	4	
	Drill bit	1	
Hose	Red hose	2	
	Blue hose	1	
	Transparent hose	2	
	Black hose	1	
Accessories	Wrenches	2	
	Core Guide	1	
	Core Breaker	1	
	Rope	2	
	Bungie Cord	3	